

Koşulsuz Müşteri Memnuniyeti

DÜŞÜK ve YÜKSEK ALAŞIMLI ÇELİKLER - ALAŞIMSIZ KARBON ÇELİKLERİ  
KİMYASAL VE ISIL DİRENÇLİ PASLANMAZ ÇELİKLER  
AŞINMA DİRENÇLİ YÜKSEK MANGANLI ÇELİKLER  
YÜKSEK KROMLU BEYAZ DÖKME DEMİRLER  
10 KG İLE 10 TON ARASI ÜRETİM ESNEKLİĞİ  
Nİ-HARD SERİSİ - SFERO DÖKME DEMİR



# AND DÖKÜM

Makina Model Sanayi ve Tic. Ltd. Şti.

[www.anddokum.com.tr](http://www.anddokum.com.tr)

## ■ ■ ■ FİRMA PROFİLİ

And Döküm Makine Model Sanayi ve Ticaret Limited Şirketi 1981 yılında kurulmuştur. Halen Ankara 1.Organize Sanayi Bölgesi Dökümcüler Sitesinde 3000 m<sup>2</sup> kapalı üretim alanı, indüksiyon ergitme ocakları, 2500 ton/yıl kapasitesi ile faaliyetini sürdürmektedir.

30 yılı aşan bilgi birikimi ve kaliteden ödün vermez ilkesi ile döküm sektörünün gelişimine katkıda bulunmaktadır. Kuruluşundan günümüze, gelişen teknolojiye paralel, her geçen gün kalite ve kapasitesini artırmakta, yeni yatırım projeleri ile de geleceğe ışık tutmaktadır.

Sunulan ürün ve fiyat avantajlarıyla, müşterilerimizle paylaştığımız kalite, güven ve memnuniyet değerlerimizi yarına taşıyabilecek, her biri kendi alanında tecrübeli personelimizle, ISO 9001 Kalite Yönetim Sistemi, ISO 14001 Çevre Yönetim Sistemi ve OHSAS 18001 İşçi Sağlığı ve Güvenliği Yönetim Sistemi belgelendirme çalışmalarını tamamlayarak, kalite, çevre ve iş güvenliği anlayışını sertifikalarıyla perçinlemiştir.

Bugün And Döküm, gelişen teknoloji elemanlarını kullanarak döküm sektöründe örnek bir işletme oluşumuna ve markalaşma çalışmalarına aralıksız devam etmektedir.



## ■ ■ ■ ABOUT US

And Casting Machine Pattern Ind&Trade Co. founded in Ankara in 1981. Today, And Casting has a capacity of 2500 tons/year with induction furnaces and still carries out its production in a closed area of 3000 m<sup>2</sup> in Sincan-Ankara Organized Industry Zone.

More than 30 year experience and quality focused principles; And Casting contributes to the development of casting industry. Parallel to the developing technology, And Casting also increases its capacity and quality day by day since from the foundation.

With fully experienced and professional staff that can carry on sharing the values like quality, trust and pleasure with customers in the future, And Casting finished certification studies of quality management system, environmental management system and occupational health and safety management system, and have taken them all.

Today And Casting, continue to work hard for being a trade mark and a model company in casting industry by using developing technology equipments.

## KALIPLAMA



10 Ton/saat sürekli kum karıştırıcı reçine mikseri (Omega)

Yaş kum kalıplama

10 Tons/hr Continuous Sand Mixer

Green Sand Molding

## ERGİTİM



500 Kg kapasiteli 2 adet indüksiyon ocağı

2500 Kg kapasiteli 2 adet indüksiyon ocağı

2 Induction Furnaces (Each have 500 Kg capacity)

2 Induction Furnaces (Each have 2500 Kg capacity)

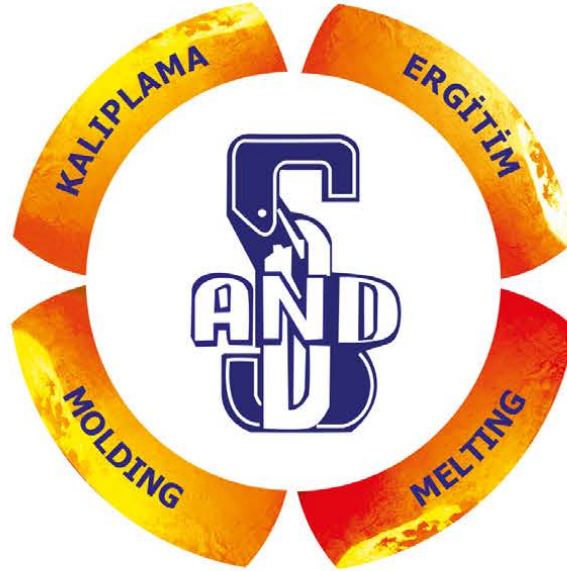

## TEMİZLEME



2 Adet Askılı Kumlama  
Makinası

2 Shot Blasting Machines

## ISIL İŞLEM



10 Ton ve 5 Ton  
Kapasiteli Isıl İşlem  
Fırınları

2 Heat Treatment  
Furnaces with 10 Tons  
and 5 Tons Capacity

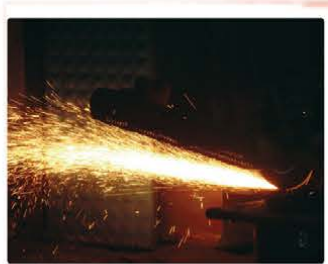
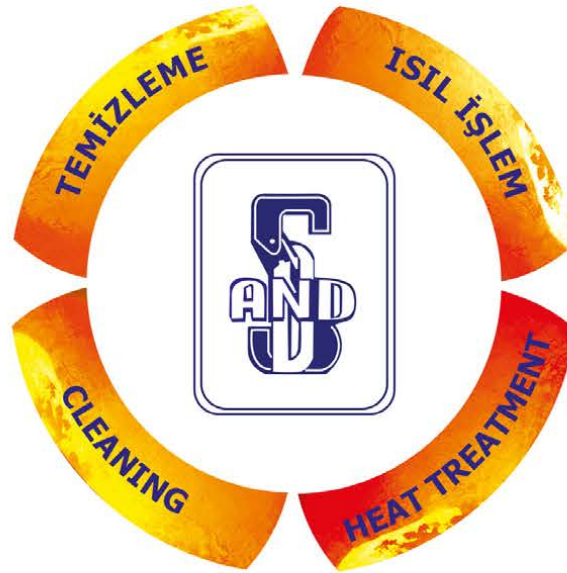

■ ■ ■ HİZMET SEKTÖRÜ / FUNCTION SECTOR



**GENEL MAKİNA İMALATI**

**MADEN ve TAŞ KIRMA**

**ÇİMENTO**

**DEMİR ÇELİK**

**İNŞAAT**

**DEMİR YOLU**

**ENERJİ**

**GEMİ İNŞA**

**VANA ve POMPA**



**GENERAL MACHINE PRODUCTION**

**MINING and STONE CRUSHING**

**CEMENT**

**IRON & STEEL**

**CONSTRUCTION**

**RAILWAY**

**ENERGY**

**SHIP BUILDING**

**VALVE and PUMP**



## ÜRÜNLER / PRODUCTS

**DÜŞÜK VE YÜKSEK ALAŞIMLI  
ÇELİKLER**

**ALAŞIMSIZ KARBON ÇELİKLERİ**

**KİMYASAL VE ISIL DİRENÇLİ  
PASLANMAZ ÇELİKLER**

**AŞINMA DİRENÇLİ YÜKSEK  
MANGANLI ÇELİKLER**

**YÜKSEK KROMLU BEYAZ  
DÖKME DEMİRLER**

**Nİ-HARD SERİSİ**

**PİK DÖKME DEMİR  
(GG SERİSİ)**

**SFERO DÖKME DEMİR  
(GGG SERİSİ)**

**PRODUCTION ELASTICITY  
BETWEEN 10 KG - 10 TON**



KATRAK VOLAN / FLYWHEEL (8500 kg)



**10 KG İLE 10 TON ARASI  
ÜRETİM ESNEKLİĞİ**

**LOW AND HIGH ALLOY STEELS**

**CARBON STEELS**

**CHEMICAL AND HEAT  
RESISTANT  
STAINLESS STEELS**

**WEAR RESISTANT  
MANGANESE  
(HAD FIELD) STEELS**

**HIGH CHROMIUM WHITE  
CAST IRONS**

**Nİ-HARD SERIES**

**GRAY CAST IRONS  
(GG SERIES)**

**NODULAR CAST IRONS  
(GGG SERIES)**



KURŞUN POTASI / LEAD MELTING POT (12500 kg)

ÜRÜNLER / PRODUCTS



Deęirmen Ring (5800 kg)

Mill Ring (5800 kg)



Vana Gvdesi (800 kg)

Valve Body (800 kg)



Salyangoz Pompa Gvdesi (1790 kg)

Spiral Pump Body (1790 kg)



Adaptr (900 kg)

Adapter (900 kg)

ÜRÜNLER / PRODUCTS

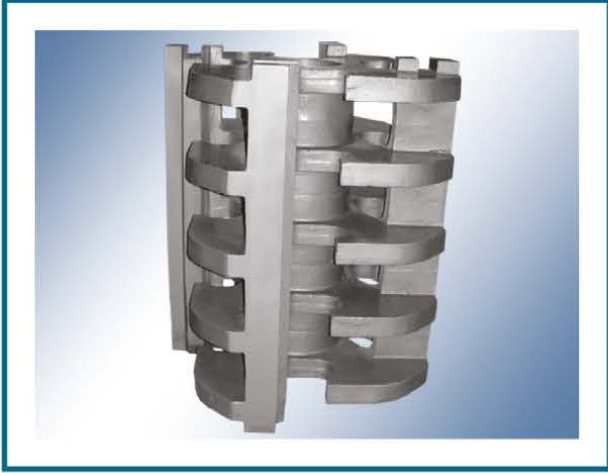

Rotor (2460 kg)

Rotor (2460 kg)



Dişli (2200 kg)

Gear (2200 kg)

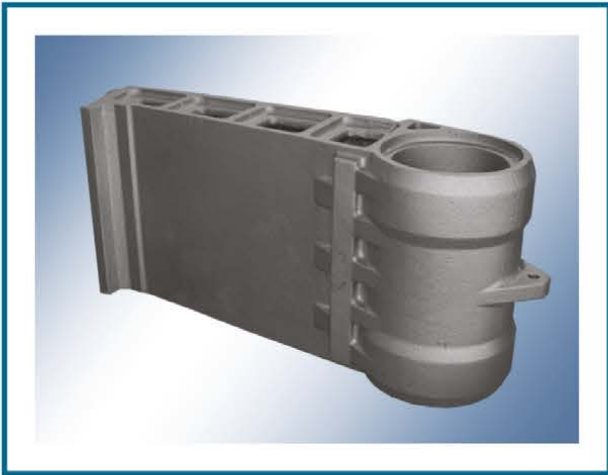

Pitman (2600 kg)

Jaw Stock (2600 kg)

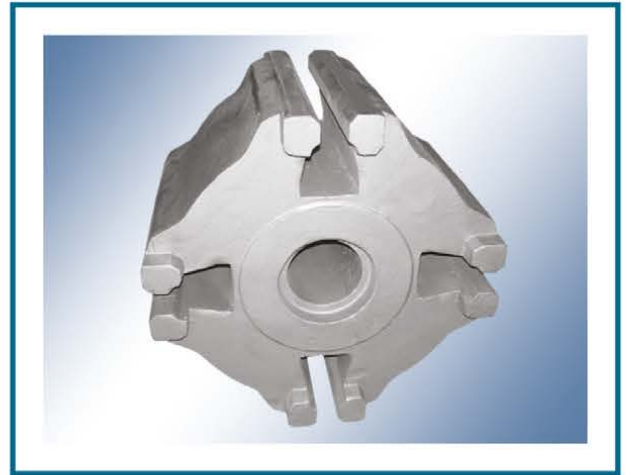

Rotor (4750 kg)

Rotor (4750 kg)



ÜRÜNLER / PRODUCTS



Çeneler

Crusher Jaw Plate



Yürüyüş Tekerleri (1950 kg)

Walking Wheel (1950 kg)



Çamur Pompa Fanı (300 kg)

Clay Pump Fan (300 kg)



Enerji Türbin Fanı (60kg)

Energy Mill Fan (60kg)

## ÜRÜNLER / PRODUCTS



Elek Kasnakları ve Elek Yatağı

Pulleys and Sieve Bed



Pompa Gövdesi

Pump



Volan

Flywheel



Mesnet Plk Yuvası

Plate House

ÜRÜNLER / PRODUCTS



Volan

Flywheel



Yan Yatak ve Labirentler

Bearing Housing and Flanges



Yan Astar

Side Coatings

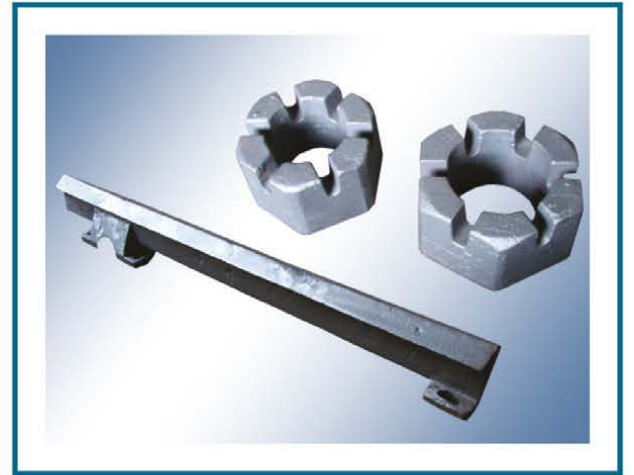

Taęlı Somun | B. Izgara

Turn Screw | Feeding Bar

ÜRÜNLER / PRODUCTS



Pitman (6500 kg)

Jaw Stock (6500 kg)



Yan Yatak + Kep

Bearing Housing



Volan (3340 kg)

Flywheel (3340 kg)



Çene (1460 kg)

Crusher Jaw Plate (1460 kg)

ÜRÜNLER / PRODUCTS



İtici Başlığı (3500 kg)

Driving Head (3500 kg)

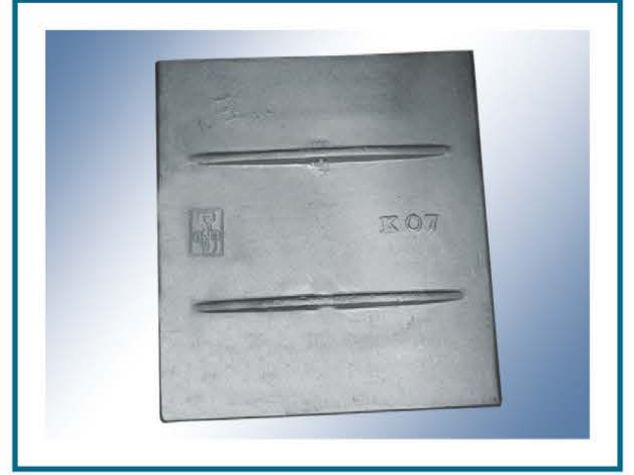

Emniyet Plakası (320 kg)

Safety Plate (320 kg)



Yan Astar

Side Coating



Değirmen Astarı

Mill Coating

## ÜRÜNLER / PRODUCTS



Kırıcı Palet

Crusher Pallet



Kırıcı Palet

Crusher Pallet

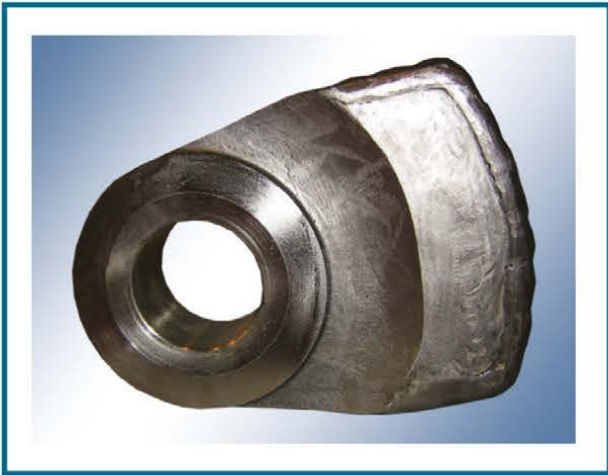

Kırıcı Çekiç

CrusherHammer



Kırıcı Palet

Crusher Pallet

ÜRÜNLER / PRODUCTS



Disk

Rotor Disc



Palet / Kaburga

Pallet / Armour Plate



Rotor (4470 kg)

Rotor (4470 kg)

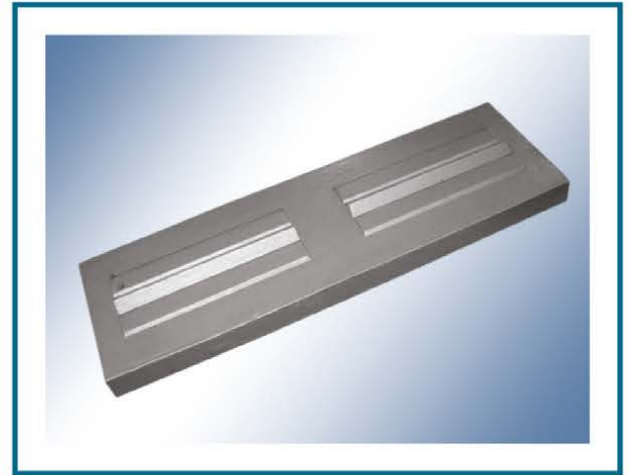

Kırıcı Palet

Crusher Pallet

ÜRÜNLER / PRODUCTS



Öğütücü

Grinder



Kırıcı Çekiç

Crusher Hammer

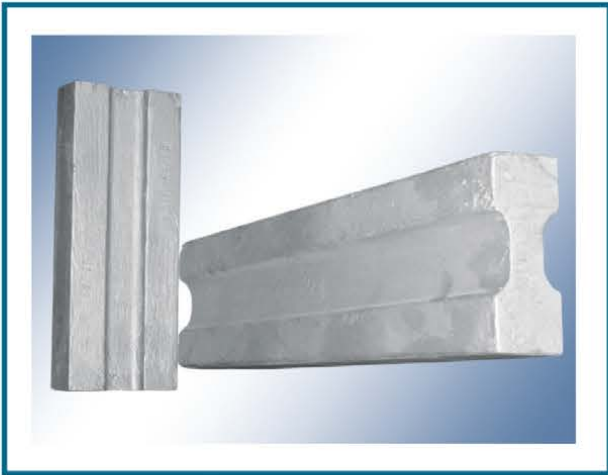

Öğütücü Profil

Grinding Bars



Çekiç

Hammer



ÜRÜNLER / PRODUCTS

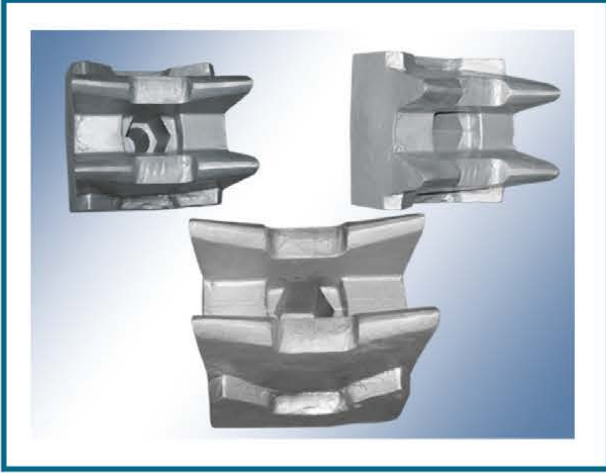

Yön Verici

Directional Transmitter



Tavan Astarı

Upper Coating



Kırıcı Çekiç

Crusher Hammer



Önlük (6150 kg)

Apron (6150 kg)

## ÜRÜNLER / PRODUCTS



İç Manto

The Inner Mantle



Volan

Flywheel



Elek Yatakları

Flanges

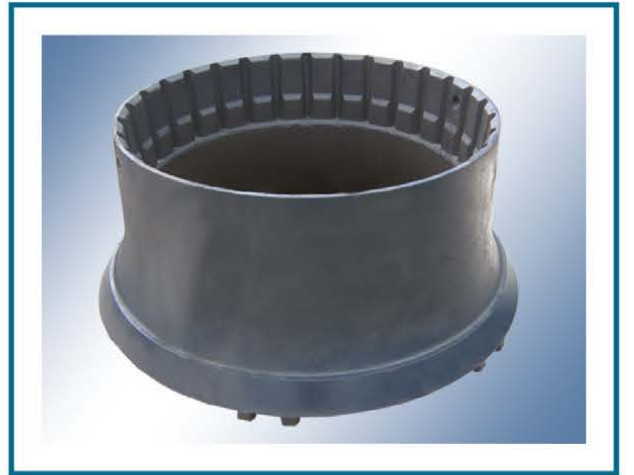

Dış Manto

The Outer Mantle

KALİTE KONTROL / QUALITY CONTROL

SPEKTRAL ANALİZ

SICAKLIK ÖLÇME

SERTLİK TESTİ

MİKROYAPI İNCELEMESİ

SIVI PENETRANT TESTİ

ÖLÇÜ KONTROL



SPECTRAL ANALYSIS

HEAT MEASURING

HARDNESS TEST

MICROSTRUCTURE INSPECTION

LIQUID PENETRANT TEST

DIMENSIONAL CONTROL



SERTİFİKALARIMIZ / OUR CERTIFICATES

KALİTE YÖNETİM SİSTEMİ



QUALITY MANAGEMENT SYSTEM

İŞÇİ SAĞLIĞI ve İŞ GÜVENLİĞİ  
YÖNETİM SİSTEMİ



OCCUPATIONAL HEALTH and SAFETY  
MANAGEMENT SYSTEM

ÇEVRE YÖNETİM SİSTEMİ



ENVIRONMENTAL MANAGEMENT SYSTEM

Absolute Customer Satisfaction

LOW AND HIGH ALLOY STEELS - CARBON STEELS  
CHEMICAL AND HEAT RESISTANT STAINLESS STEELS  
WEAR RESISTANT MANGANESE (HADFIELD) STEELS  
HIGH CHROMIUM WHITE CAST IRONS - NODULAR CAST IRONS  
GRAY CAST IRONS - PRODUCTION ELASTICITY BETWEEN 10 KG - 10 TON  
Ni-HARD SERIES



# AND DÖKÜM

Makina Model Sanayi ve Tic. Ltd. Şti.

ZENAP 0312 232 35 28

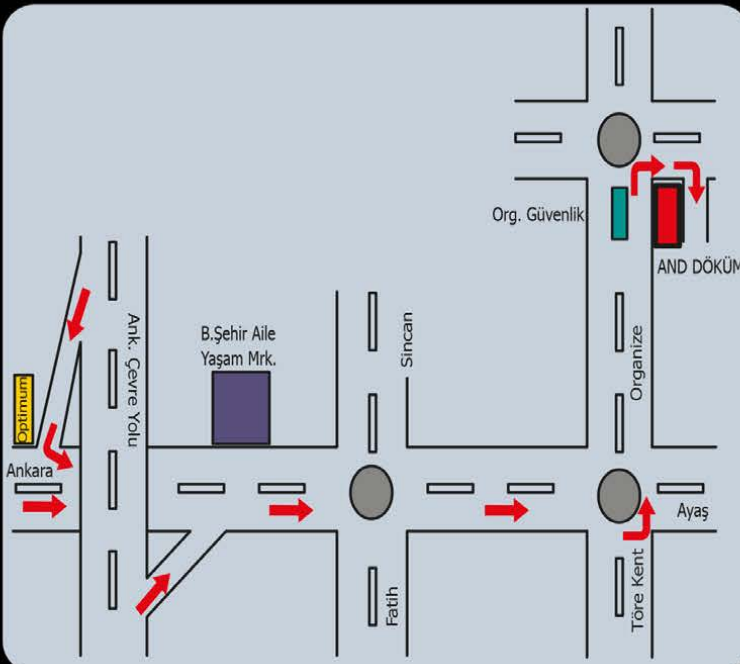

1. Organize Sanayi Bölgesi  
Dökümcüler Sitesi 196. Sokak  
(Eski 13. Sokak) No: 181  
SİNCAN - ANKARA - TURKEY

Telefon

+90 312 267 12 97

+90 312 267 41 07

Faks

+90 312 267 12 98

info@anddokum.com.tr

[www.anddokum.com.tr](http://www.anddokum.com.tr)